

Quality of S-parameter models

Asian IBIS Summit, Yokohama, November 18, 2011

Yuriy Shlepnev

shlepnev@simberian.com

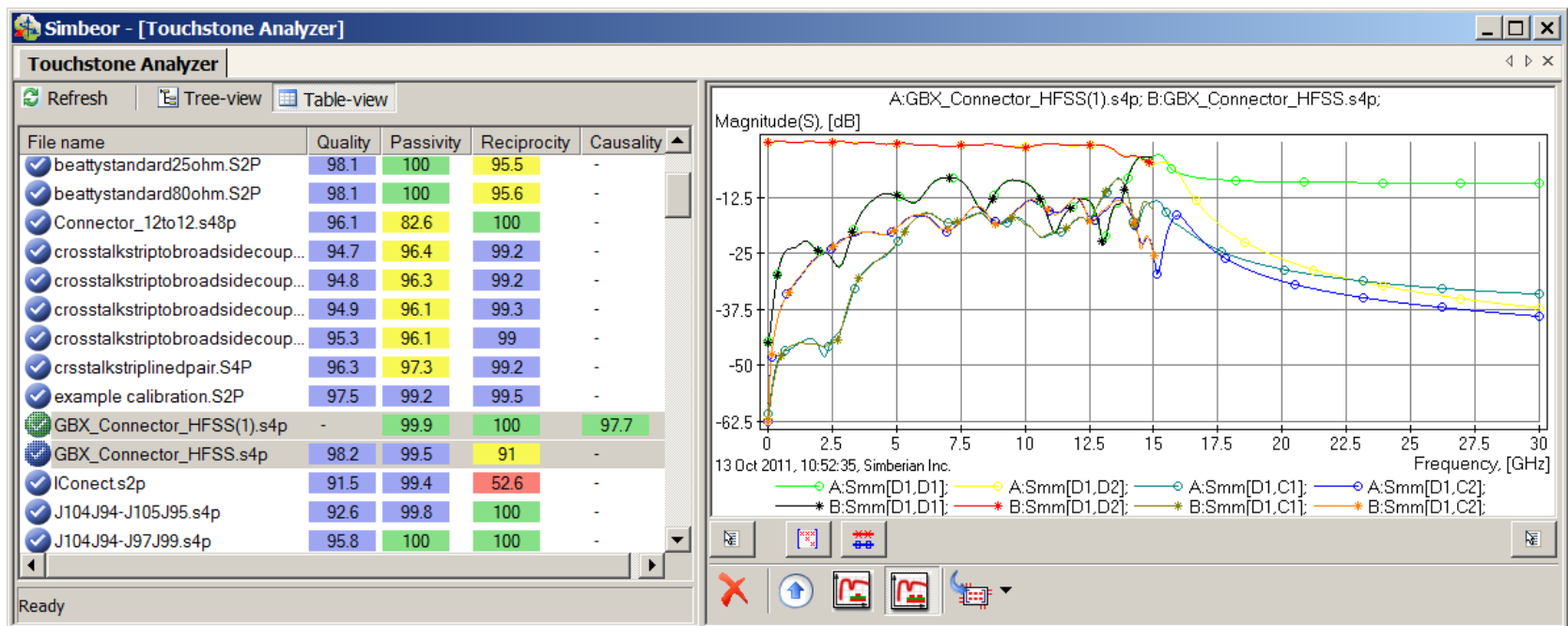

Outline

- Introduction
- S-parameters in frequency and time domains
- Constrains on S-parameters in frequency domain
- Quality metrics for reciprocity, passivity, causality
- Rational approximation and final quality metric
- Conclusion
- Contacts and resources

S-parameter models

- ❑ S-parameter models are becoming ubiquitous in design of multi-gigabit interconnects
 - Connectors, cables, PCBs, packages, backplanes, ... ,any LTI-system in general can be characterized with S-parameters from DC to daylight
- ❑ Electromagnetic analysis or measurements are used to build S-parameter Touchstone models
- ❑ Very often such models have quality issues:
 - Reciprocity violations
 - Passivity and causality violations
 - Common sense violations
- ❑ **And produce different time-domain and even frequency-domain responses in different solvers!**

System response computation requires frequency-continuous S-parameters from DC to infinity

$$S(i\omega) = \int_{-\infty}^{\infty} S(t) \cdot e^{-i\omega t} \cdot dt, \quad S(i\omega) \in \mathbb{C}^{N \times N}$$

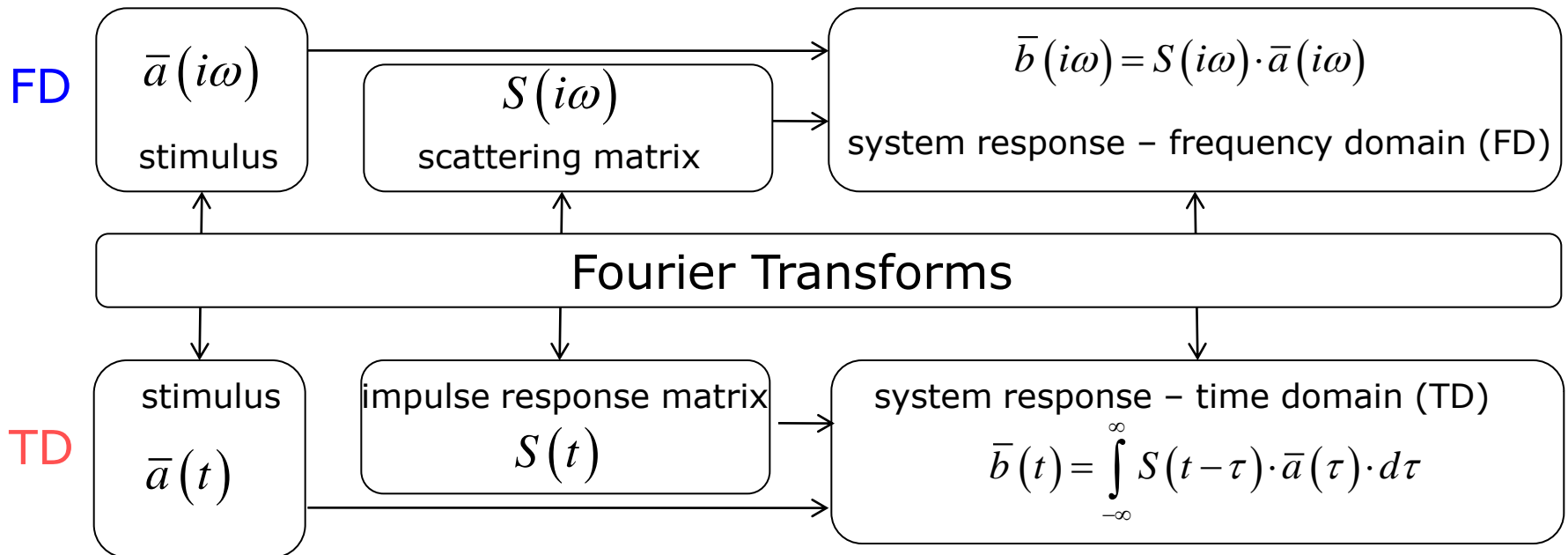

$$S(t) = \frac{1}{2\pi} \int_{-\infty}^{\infty} S(i\omega) \cdot e^{i\omega t} \cdot d\omega, \quad S(t) \in \mathbb{R}^{N \times N}$$

Possible approximations for discrete models

- ❑ Discrete Fourier Transform (DFT) and convolution
 - Slow and may require interpolation and extrapolation of tabulated S-parameters (uncontrollable error)
- ❑ Approximate discrete S-parameters with rational functions (RMS error)
 - Accuracy is under control over the defined frequency band
 - Frequency-continuous causal functions defined from DC to infinity with analytical impulse response
 - Fast recursive convolution algorithm to compute TD response
 - Results consistent in time and frequency domains
- ❑ Not all Touchstone models are suitable for either approach

Common S-parameter model defects

- Model **bandwidth deficiency**
 - S-parameter models are band-limited due to limited capabilities of solvers and measurement equipment
 - Model should include DC point or allow extrapolation, and high frequencies defined by the signal spectrum
- Model **discreteness**
 - Touchstone models are matrix elements at a set of frequencies
 - Interpolation or approximation of tabulated matrix elements may be necessary both for time and frequency domain analyses
- Model **distortions** due to
 - Measurement or simulation artifacts
 - Passivity violations and local “enforcements”
 - Causality violations and “enforcements”
- Human mistakes of model developers and users
- **How to estimate and rate quality of the models?**

Causality of LTI system (TD & FD)

- The system is causal if and only if all elements of the time-domain impulse response matrix are $S_{i,j}(t) = 0$ at $t < 0$

delayed causality (for interconnects):

$$S_{i,j}(t) = 0 \text{ at } t < T_{i,j}, T_{i,j} > 0$$

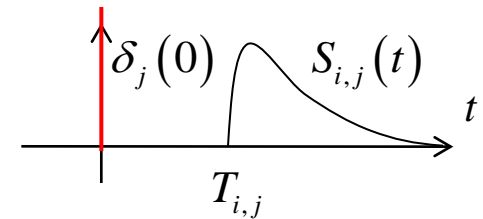

- This leads to Kramers-Kronig relations in frequency-domain

$$S(i\omega) = \frac{1}{i\pi} PV \int_{-\infty}^{\infty} \frac{S(i\omega')}{\omega - \omega'} \cdot d\omega', \quad PV = \lim_{\varepsilon \rightarrow 0} \left(\int_{-\infty}^{\omega - \varepsilon} + \int_{\omega + \varepsilon}^{\infty} \right)$$

$$S_r(\omega) = \frac{1}{\pi} PV \int_{-\infty}^{\infty} \frac{S_i(\omega')}{\omega - \omega'} \cdot d\omega', \quad S_i(\omega) = \frac{-1}{\pi} PV \int_{-\infty}^{\infty} \frac{S_r(\omega')}{\omega - \omega'} \cdot d\omega'$$

Kramers, H.A., Nature, v 117, 1926 p. 775..
Kronig, R. de L., J. Opt. Soc. Am. N12, 1926, p 547.

derivation

$$S(t) = \text{sign}(t) \cdot S(t),$$

$$\text{sign}(t) = \begin{cases} -1, & t < 0 \\ 1, & t > 0 \end{cases} \quad \begin{array}{c} \uparrow \\ \text{---} \\ \text{---} \\ \downarrow \end{array}$$

$$S(i\omega) = F\{S(t)\} =$$

$$= \frac{1}{2\pi} F\{\text{sign}(t)\} * F\{S(t)\}$$

$$F\{\text{sign}(t)\} = \frac{2}{i\omega}$$

Causality estimation - difficult way

- ❑ Kramers-Kronig relations **cannot be directly used to verify causality** for the frequency-domain response known over **the limited bandwidth at some points**
- ❑ Causality boundaries can be introduced to estimate causality of the tabulated and band-limited data sets
 - Milton, G.W., Eyre, D.J. and Mantese, J.V, *Finite Frequency Range Kramers Kronig Relations: Bounds on the Dispersion*, Phys. Rev. Lett. 79, 1997, p. 3062-3064
 - Triverio, P. Grivet-Talocia S., *Robust Causality Characterization via Generalized Dispersion Relations*, IEEE Trans. on Adv. Packaging, N 3, 2008, p. 579-593.

Even if test passes – a lot of uncertainties due to band limitedness

Causality estimation - easy way

- “Heuristic” causality measure based on the observation that polar plot of a causal system rotates mostly clockwise (suggested by V. Dmitriev-Zdorov)

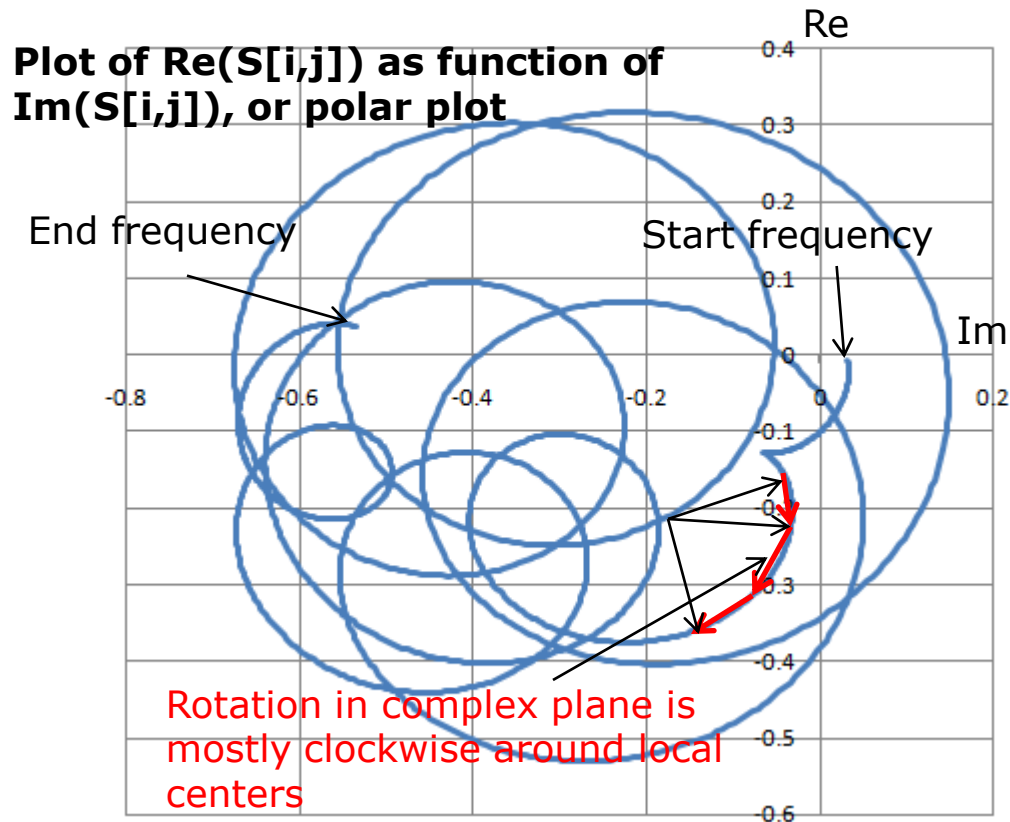

Causality measure (CM) can be computed as the ratio of clockwise rotation measure to total rotation measure in %.

If this value is below 80%, the parameters are reported as suspect for possible violation of causality.

Algorithm is good for numerical models (to find under-sampling), but no so good for measured data due to noise!

Stability and passivity in time-domain

- The system is stable if output is bounded for all bounded inputs

$$|a(t)| < K \Rightarrow |b(t)| < M, \forall t \quad (\text{BIBO})$$

- A multiport network is passive if energy absorbed by multiport

$$E(t) = \int_{-\infty}^t [\bar{a}^t(\tau) \cdot \bar{a}(\tau) - \bar{b}^t(\tau) \cdot \bar{b}(\tau)] \cdot d\tau \geq 0, \forall t \quad (\text{does not generate energy})$$

for all possible incident and reflected waves

- If the system is passive according to the above definition, it is also causal

$$\bar{a}(t) = 0, \forall t < t_0 \Rightarrow \int_{-\infty}^t [\bar{b}^t(\tau) \cdot \bar{b}(\tau)] \cdot d\tau \leq 0 \Rightarrow \bar{b}(t) = 0, \forall t < t_0$$

- Thus, we need to check only the passivity of interconnect system!

P. Triverio S. Grivet-Talocia, M.S. Nakhla, F.G. Canavero, R. Achar, Stability, Causality, and Passivity in Electrical Interconnect Models, IEEE Trans. on Advanced Packaging, vol. 30. 2007, N4, p. 795-808.

Passivity in frequency domain

- Power transmitted to multiport is a difference of power transmitted by incident and reflected waves:

$$P_{in} = \sum_{n=1}^N |a_n|^2 - |b_n|^2 = [\bar{a}^* \cdot \bar{a} - \bar{b}^* \cdot \bar{b}]$$

or
$$P_{in} = \bar{a}^* \cdot \bar{a} - \bar{a}^* \cdot S^* S \cdot \bar{a} = \bar{a}^* \cdot [U - S^* S] \cdot \bar{a}$$

- Quadratic form is non-negative if eigenvalues of the matrix are non-negative:

$$\text{eigenvals}[U - S^* \cdot S] \geq 0 \quad \Rightarrow \quad \text{eigenvals}[S^* \cdot S] \leq 1$$

(U is unit matrix)

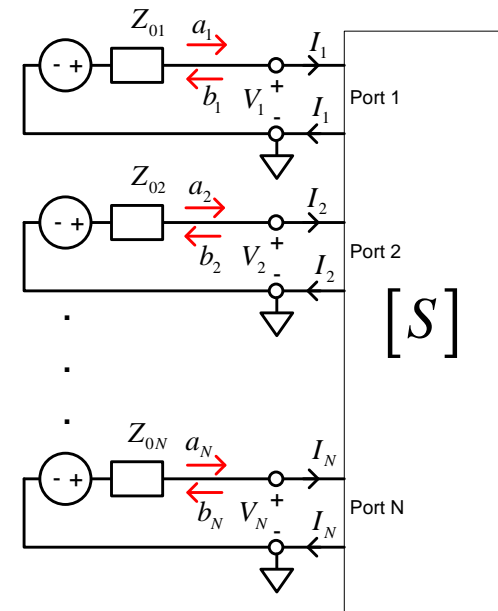

*Sufficient condition only if verified from DC to infinity
(impossible for discrete Touchstone models)*

Good Touchstone models of interconnects

- ❑ Must have sufficient bandwidth matching signal spectrum
- ❑ Must be appropriately sampled to resolve all resonances
- ❑ Must be reciprocal (linear reciprocal materials used in PCBs)

$$S_{i,j} = S_{j,i} \text{ or } S = S^t$$

- ❑ Must be passive (do not generate energy)

$$P_{in} = \bar{a}^* \cdot [U - S^* S] \cdot \bar{a} \geq 0 \quad \Rightarrow \quad \text{eigenvals}[S^* \cdot S] \leq 1 \quad \text{from DC to infinity!}$$

- ❑ Have causal step or impulse response (response only after the excitation)

$$S_{i,j}(t) = 0, \quad t < T_{ij}$$

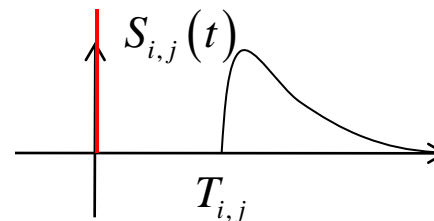

Quality metrics (0-100%) to define goodness

First introduced at IBIS forum at DesignCon 2010

Passivity Quality Measure:

$$PQM = \max \left[\frac{100}{N_{total}} \left(N_{total} - \sum_{n=1}^{N_{total}} PW_n \right), 0 \right] \% \quad PW_n = 0 \text{ if } PM_n < 1.00001; \text{ otherwise } PW_n = \frac{PM_n - 1.00001}{0.1}$$

should be >99%

$$PM_n = \sqrt{\max \left[\text{eigenvals} \left(S^*(f_n) \cdot S(f_n) \right) \right]}$$

Reciprocity Quality Measure:

$$RQM = \max \left[\frac{100}{N_{total}} \left(N_{total} - \sum_{n=1}^{N_{total}} RW_n \right), 0 \right] \% \quad RW_n = 0 \text{ if } RM_n < 10^{-6}; \text{ otherwise } RW_n = \frac{RM_n - 10^{-6}}{0.1}$$

should be >99%

$$RM_n = \frac{1}{N_s} \sum_{i,j} |S_{i,j}(f_n) - S_{j,i}(f_n)|$$

- Causality Quality Measure: Minimal ratio of clockwise rotation measure to total rotation measure in % (should be >80% for numerical models)

Preliminary quality estimation metrics

- Preliminary Touchstone model quality can be estimated with Passivity, Reciprocity and Causality quality metrics (PQM, RQM, CQM)

Metric/Model Icon	✔ - good	✔ - acceptable	⚠ - inconclusive	✖ - bad
Passivity	[100, 99.9]	(99.9, 99]	(99, 80]	(80, 0]
Reciprocity	[100, 99.9]	(99.9, 99]	(99, 80]	(80, 0]
Causality	[100, 80]	(80, 50]	(50, 0]	-----

Color code	Passivity (PQM)	Reciprocity (RQM)	Causality (CQM)
Green – good	[99.9, 100]	[99.9, 100]	[80, 100]
Blue – acceptable	[99, 99.9)	[99, 99.9)	[50, 80)
Yellow – inconclusive	[80, 99)	[80, 99)	[20, 50)
Red - bad	[0, 80)	[0, 80)	[0, 20)

Example of preliminary quality estimation

Small passivity & reciprocity violations in most of the models
Low causality in some measured data due to noise at high frequencies

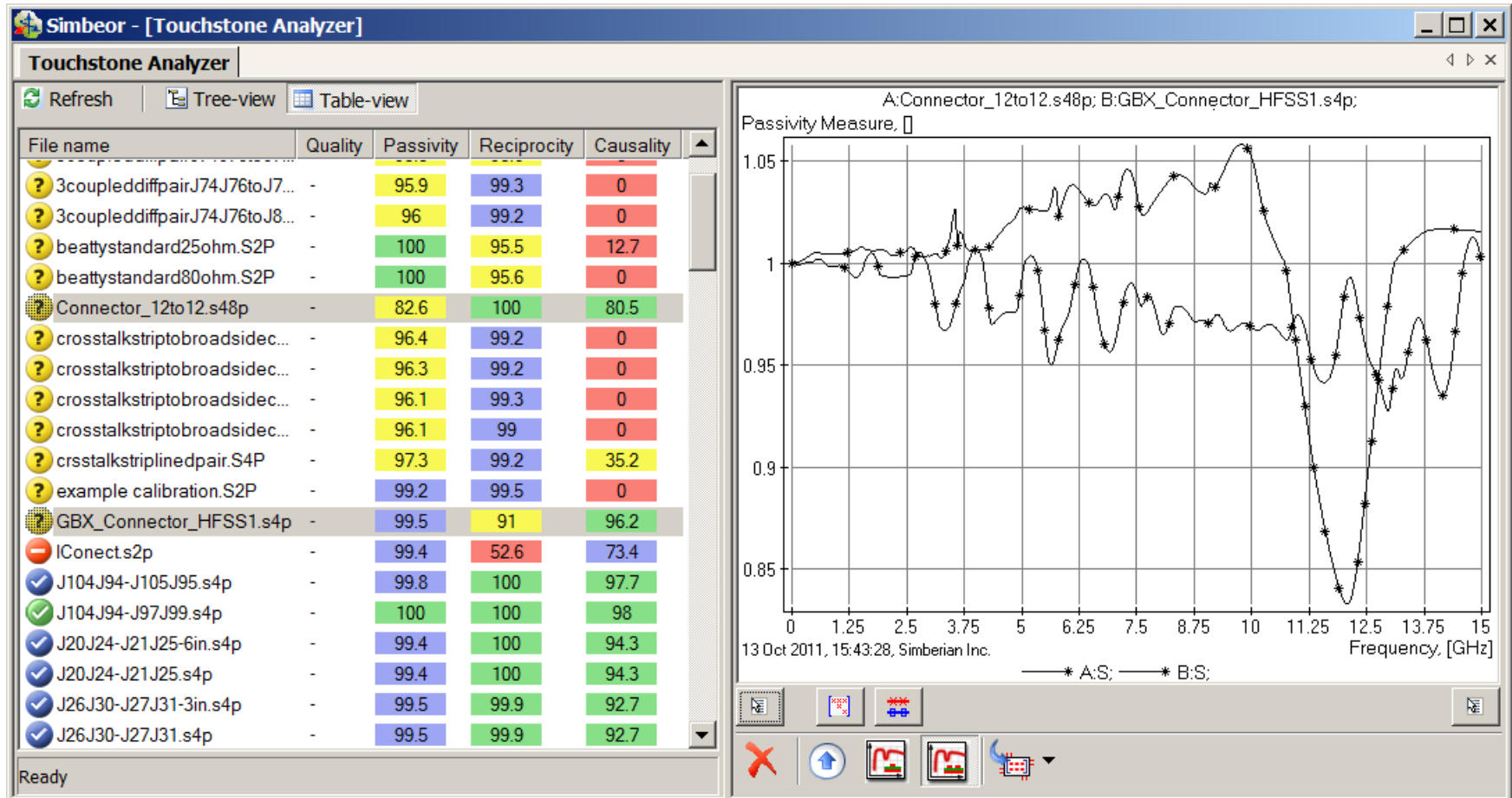

Rational approximation of S-parameters as the frequency-continuous model

$$\bar{b} = S \cdot \bar{a}, \quad S_{i,j} = \frac{b_i}{a_j} \Big|_{a_k=0, k \neq j} \Rightarrow S_{i,j}(i\omega) = \left[d_{ij} + \sum_{n=1}^{N_{ij}} \left(\frac{r_{ij,n}}{i\omega - p_{ij,n}} + \frac{r_{ij,n}^*}{i\omega - p_{ij,n}^*} \right) \right] \cdot e^{-s \cdot T_{ij}}$$

$s = i\omega$, d_{ij} – values at ∞ , N_{ij} – number of poles,
 $r_{ij,n}$ – residues, $p_{ij,n}$ – poles (real or complex), T_{ij} – optional delay

Continuous functions of frequency defined from DC to infinity

- Pulse response is analytical, real and delay-causal:

$$S_{i,j}(t) = 0, \quad t < T_{ij}$$

$$S_{i,j}(t) = d_{ij} \delta(t - T_{ij}) + \sum_{n=1}^{N_{ij}} \left[r_{ij,n} \cdot \exp(p_{ij,n} \cdot (t - T_{ij})) + r_{ij,n}^* \cdot \exp(p_{ij,n}^* \cdot (t - T_{ij})) \right], \quad t \geq T_{ij}$$

- Stable $\text{Re}(p_{ij,n}) < 0$

- Passive if $\text{eigenvals}[S(\omega) \cdot S^*(\omega)] \leq 1 \quad \forall \omega, \text{ from } 0 \text{ to } \infty$

- Reciprocal if $S_{i,j}(\omega) = S_{j,i}(\omega)$

May require enforcement

Rational approximation can be used to

- ❑ Compute time-domain response of a channel with a fast recursive convolution algorithm (exact solution for PWL signals)
- ❑ Improve quality of tabulated Touchstone models
 - Fix minor passivity and causality violations
 - Interpolate and extrapolate with guaranteed passivity
- ❑ Produce broad-band SPICE macro-models
 - Smaller model size, stable analysis
 - Consistent frequency and time domain analyses in any solver
- ❑ **Measure the original model quality**

Final quality estimation

- Accuracy of discrete S-parameters approximation with frequency-continuous macro-model, passive from DC to infinity

$$RMSE = \max_{i,j} \left[\sqrt{\frac{1}{N} \sum_{n=1}^N |S_{ij}(n) - S_{ij}(\omega_n)|^2} \right]$$

- Can be used to estimate quality of the original data

$$Q = 100 \cdot \max(1 - RMSE, 0) \%$$

Model Icon/Quality	Quality Metric	RMSE
✓ - good	[99, 100]	[0, 0.01]
✓ - acceptable	[90, 99)	(0.01, 0.1]
? - inconclusive	[50, 90)	(0.1, 0.5]
✗ - bad	[0, 50)	> 0.5
? - uncertain	[0,100], not passive or not reciprocal	

Example of final quality estimation

All rational macro-models are passive, reciprocal, causal and have acceptable accuracy (acceptable quality of original models)

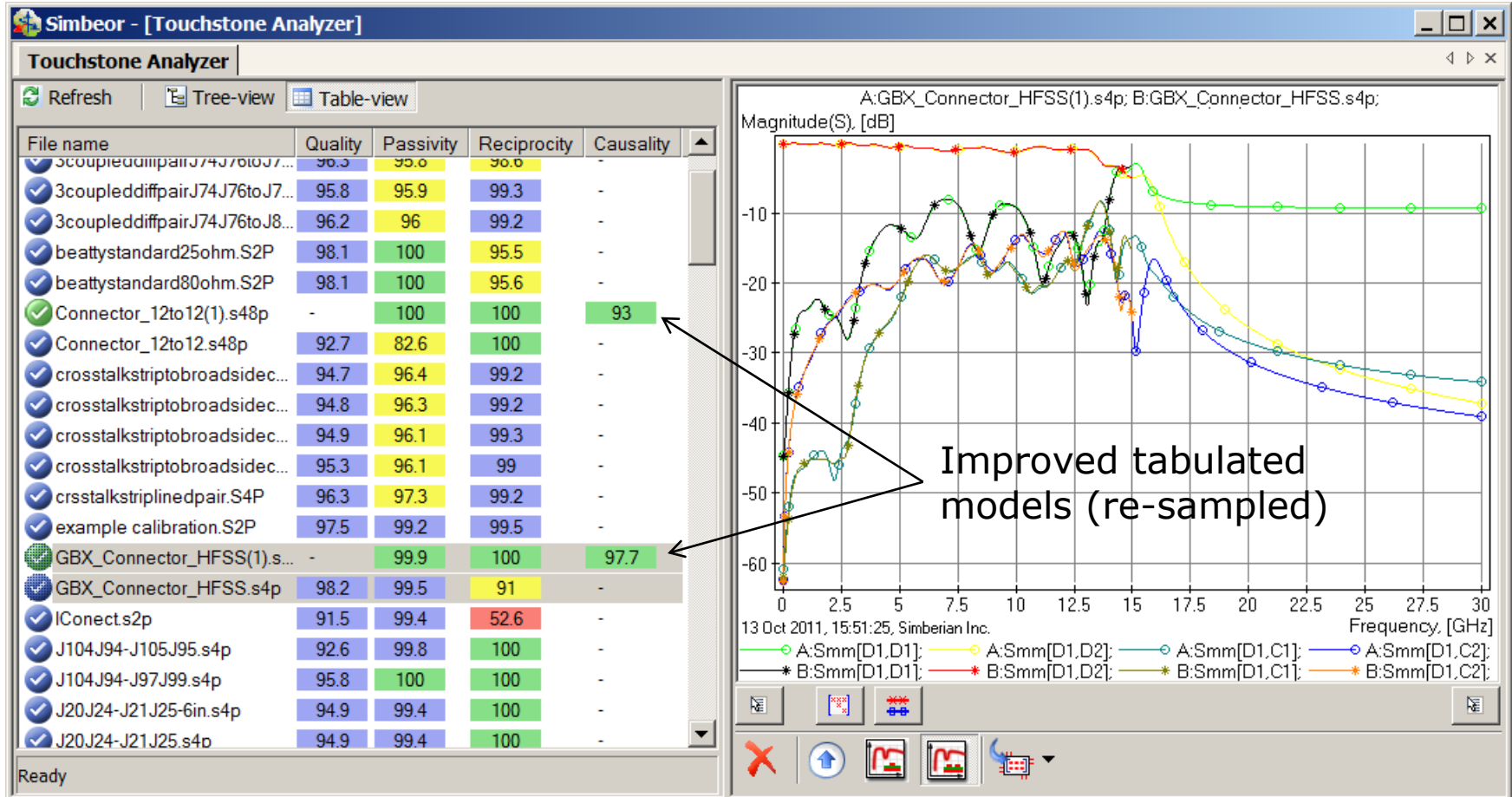

Conclusion: How to avoid problems with S-parameter models?

- Use reciprocity, passivity and causality metrics for preliminary analysis
 - RQM and PQM metrics should be > 99% (acceptable level)
 - CQM should be > 80% for all causal numerical models
- Use the rational model accuracy as the final quality measure
 - QM should be > 90% (acceptable level)
- **Discard the model with low RQM, PQM and QM metrics!**
 - The main reason is we do not know what it should be
- Models that pass the quality metrics may still be not usable or mishandled by a system simulator
 - **Due to band-limitedness, discreteness and brut force model fixing**
- Use rational or BB SPICE macro-models instead of Touchstone models for consistent time and frequency domain analyses

Contact and resources

- Yuriy Shlepnev, Simberian Inc.

shlepnev@simberian.com

Tel: 206-409-2368

- To learn more on S-parameters quality see the following presentations (also available on request):

- Y. Shlepnev, Quality Metrics for S-parameter Models, DesignCon 2010 IBIS Summit, Santa Clara, February 4, 2010
- H. Barnes, Y. Shlepnev, J. Nadolny, T. Dagostino, S. McMorrow, Quality of High Frequency Measurements: Practical Examples, Theoretical Foundations, and Successful Techniques that Work Past the 40GHz Realm, DesignCon 2010, Santa Clara, February 1, 2010.
- E. Bogatin, B. Kirk, M. Jenkins, Y. Shlepnev, M. Steinberger, How to Avoid Butchering S-Parameters, DesignCon 2011
- Y. Shlepnev, Reflections on S-parameter quality, DesignCon 2011 IBIS Summit, Santa Clara, February 3, 2011